



## B40-P & B40-H Liquid Level Switch ASME B31.1 Compliant

### DESCRIPTION

---

Magnetrol B40-P & B40-H liquid level switches are utilized in high pressure, high temperature service conditions. They are designed, constructed and certified to the ASME B31.1 Power Piping code.

### FEATURES

---

- Choices of chamber materials are carbon steel, stainless steel and chrome-moly
- 300 series stainless steel float
- Choice of switch mechanism:
  - Dry contact
  - Hermetically sealed
- Minimum specific gravity 0.65
- Choice of switch mechanism enclosure:
  - TYPE 4X polymer coated steel
  - TYPE 4X/7/9 Class I, Div. 1, Groups C & D, polymer coated aluminum or cast iron
  - TYPE 4X/7/9 Class I, Div. 1, Group B, polymer coated aluminum or cast iron
- Choice of tank connection:
  - 1" butt welds
  - 1" or 1½" socket welds

### OPTIONS

---

- ATEX housing
- Flanged connections
- Temperature extensions
- Low specific gravity calibration
- Additional QC testing



### APPLICATIONS

---



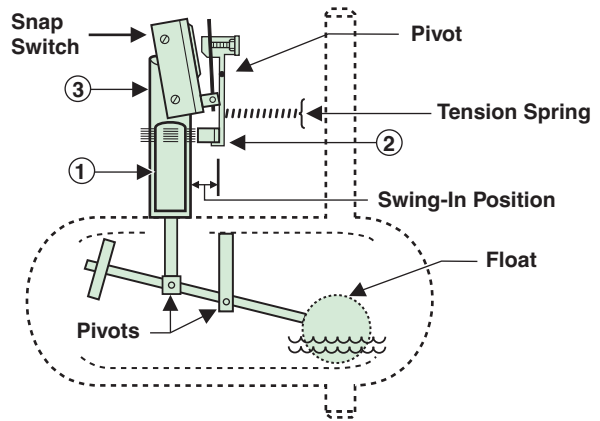

- Accumulators
- Receivers
- Flash tanks
- Knock-out drums
- Storage tanks
- Separators
- Drip Legs

# TECHNOLOGY

B40 level switches employ permanent magnetic force as the link between the float and the switching element. As the pivoted float follows liquid level changes, it moves a magnetic sleeve ① into or out of the field of a switch actuating magnet ② causing switch operation. A non-magnetic barrier tube ③ effectively isolates the switch mechanism from the controlled liquid.



# AGENCY APPROVALS

AGENCY	APPROVED MODEL	APPROVAL CLASSES
<b>FM</b>  APPROVED	All with an electric switch mechanism and a housing listed as Type 4X/7/9	Class I, Div 1, Groups C & D Class II, Div 1, Groups E, F & G
	All with an electric switch mechanism and a housing listed as Type 4X/7/9 Class I, Div 1, Group B	Class I, Div 1, Groups B, C & D Class II, Div 1, Groups E, F & G
<b>CSA</b> 	All with a Series F, HS, 8 or 9 electric switch mechanism and a housing listed as CSA Type 4X	Class I, Div 2, Groups B, C & D
	All with an electric switch mechanism and a housing listed as Type 4X/7/9	Class I, Div 1, Groups C & D Class II, Div 1, Groups E, F & G
	All with an electric switch mechanism and a housing listed as Type 4X/7/9 Class I, Div 1, Group B	Class I, Div 1, Groups B, C & D Class II, Div 1, Groups E, F & G
<b>ATEX / IEC Ex ①</b> 	All with an electric switch mechanism and an ATEX housing	ATEX II 2 G EEx d IIC T6 94/9/EC IEC Ex Ex d IIC T6
<b>CE</b> 	Low Voltage Directive 2006/95/EC Per Harmonized Standard: EN 61010-1/1993 & Amendment No. 1	Installation Category II Pollution Degree 2

① IEC Installation Instructions:

The cable entry and closing devices shall be Ex d certified suitable for the conditions of use and correctly installed.

For ambient temperatures above +55° C or for process temperatures above +150° C, suitable heat resistant cables shall be used.

Heat extensions (between process connection and housing) shall never be insulated.

**Special conditions for safe use:**

When the equipment is installed in process temperatures higher than +85° C the temperature classification must be reduced according to the following table as per IEC60079-0.

Maximum Process Temperature	Temperature Classification
< 85° C	T6
< 100° C	T5
< 135° C	T4
< 200° C	T3
< 300° C	T2
< 450° C	T1

These units are in conformity with IECEx KEM 05.0020X  
Classification Ex d IIC T6  
T<sub>ambient</sub> -40° C to +70° C

# SPECIFICATIONS

## SWITCH MECHANISMS AND ENCLOSURES

---



### SERIES C, D, R & S DRY CONTACT SWITCHES

- Designed for AC and DC current applications
- Process temperatures to +1000° F (+538° C)



### SERIES F, HS, 8 & 9 HERMETICALLY SEALED SWITCHES

- Ideal for use in salt and other corrosive atmospheres
- Positively pressurized capsule for entire mechanism and contacts
- Process temperatures to +1000° F (+538° C)



TYPE 4X Carbon Steel Enclosure



TYPE 4X/7/9 Cast Iron Enclosure



TYPE 4X/7/9 Aluminum Enclosure

### SWITCH ENCLOSURE

- TYPE 4X blue polymer coated carbon steel, weather resistant for non-hazardous areas
- TYPE 4X/7/9 blue polymer coated aluminum and cast iron enclosures
- Designed to meet Class I, Div. 1 Groups C & D and Class I, Div. 1 Group B

## ASME B31.1 CONSTRUCTION

---

### PRODUCT DESIGN

Pressure vessels are designed within code specified stress limits. Design calculations, design prints and weld qualifications are available for audit. All chamber branch and circumferential weld joints are designed to achieve FULL penetration.

### MATERIALS OF CONSTRUCTION

All pressure-retaining materials are procured with Certificates of Conformance to assure compliance of components with required standards.

### WELDING

All welding is performed by qualified welders and per procedures required by the ASME Boiler Pressure Vessel Code Sec. IX. Welds are visually inspected for FULL penetration. All other non-destructive examination is performed per ANSI B31.1.

### HYDROSTATIC TEST

All chambers are hydrostatically tested at 1.5 times the design pressure.

# BASIC ELECTRICAL RATINGS

Voltage	Switch Series and Non-Inductive Ampere Rating								
	C	D	F	HS	R	S/AC	S/DC	8	9
120 VAC	15.00	10.00	2.50	5.00	1.00	15.00	10.00	1.00	—
240 VAC	15.00	—	—	5.00	1.00	15.00	—	—	—
24 VDC	10.00	10.00	4.00	5.00	1.00	10.00	10.00	3.00	0.50
120 VDC	1.00	10.00	0.30	0.50	0.40	1.00	4.00	—	—
240 VDC	0.50	3.00	—	0.25	—	0.50	3.00	—	—

# DIMENSIONAL SPECIFICATIONS

INCHES (MM)

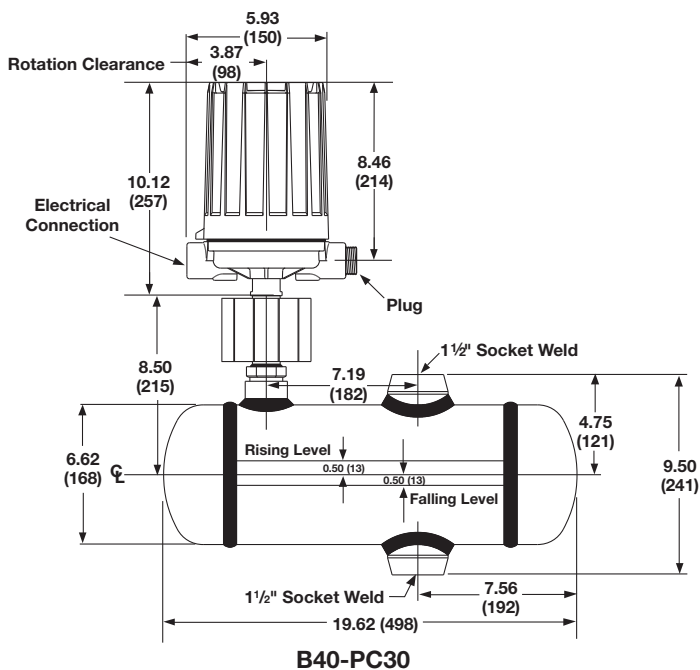

**B40-PC30**

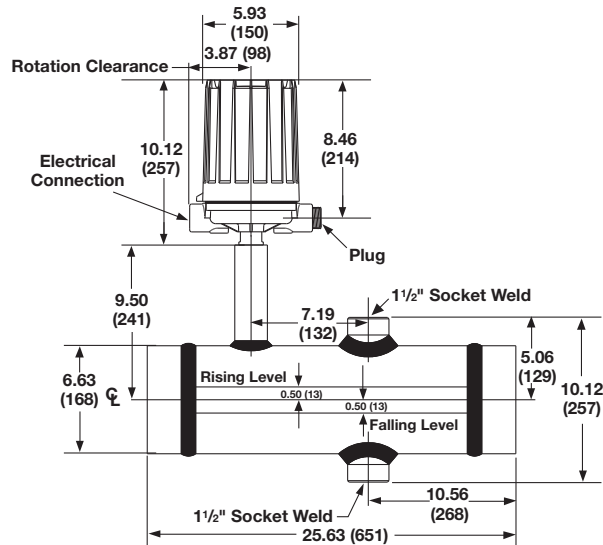

**B40-PC40 and B40-HC40**

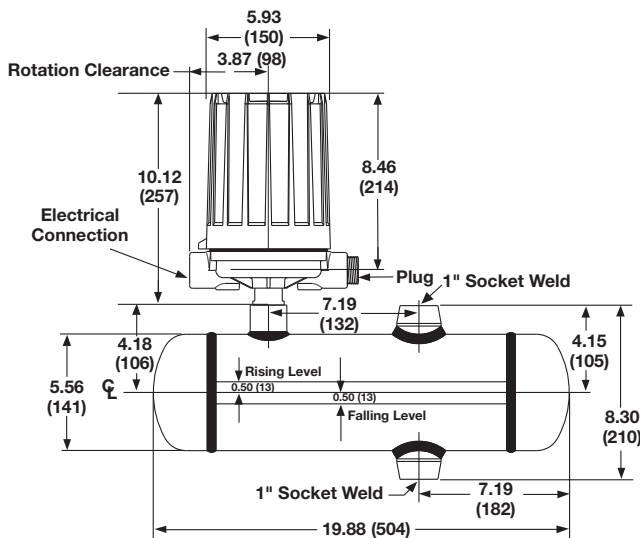

**B40-PC20**

# DIMENSIONAL SPECIFICATIONS

INCHES (MM)

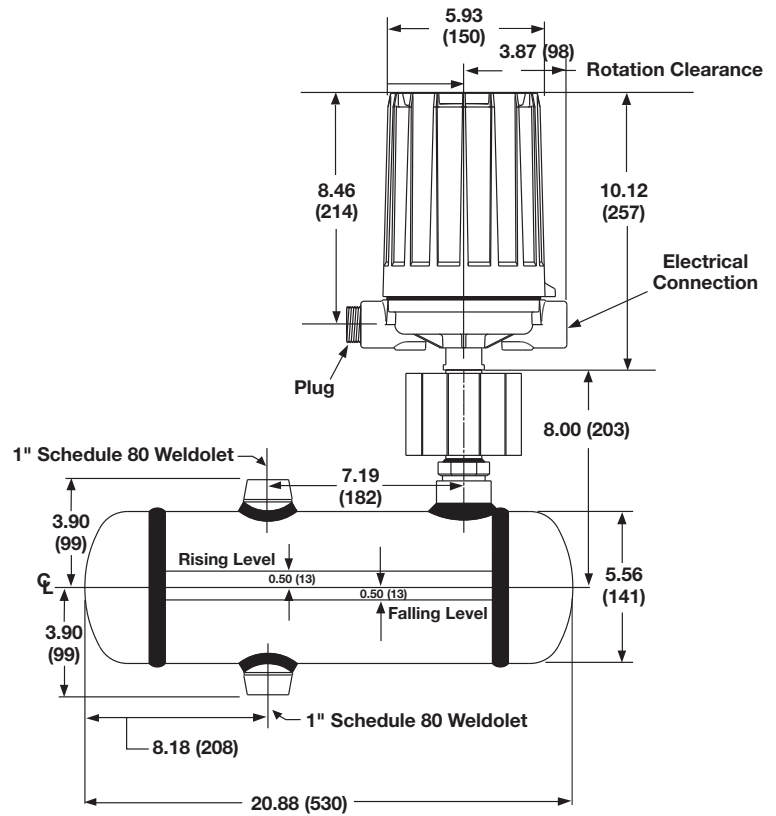

**B40-HF30 and B40-PF30**

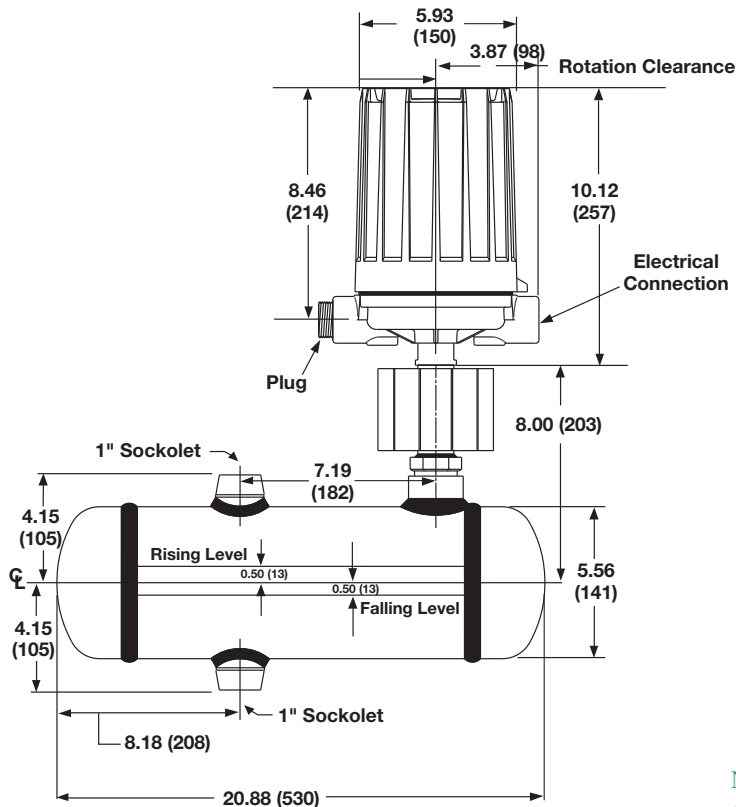

**B40-PB60 and B40-HB60**

**NOTES:**

1. Allow 8 inches (203 mm) overhead clearance for cover removal.
2. Maximum ambient temperature at switch head should not exceed +140° F (+60° C).

# MODEL NUMBER

## BASIC MODEL

B40-H	B40-H Liquid Level Switch for Temperatures Above +750° F (+399° C)
-------	--------------------------------------------------------------------

## MATERIALS OF CONSTRUCTION/PRESSURE RATING PSI (BAR)

	Chamber Material	Float Material	Tank Connection	Minimum S.G.	Temperature °F (°C)		
					750	800	1000
F30	P11/F11 Chrome-Moly	321/347 SS <sup>①</sup>	1" butt-weld	0.65	1552 (107)	1510 (104)	661 (46)
B60			1" socket weld				
C40	A312/A479 T316/316L SS		1 1/2" socket weld		3169 (218)	3129 (216)	3011 (208)

## ELECTRIC SWITCH MECHANISM AND ENCLOSURE FOR MODEL B40-HXXX ONLY

Switch Description	Process Temperature Range <sup>④</sup>	One Set Point	CS/Aluminum	Cast Iron	
			TYPE 4X	Class I, Div 1, Groups C & D	Class I, Div 1, Group B
Series R Snap Switch	-40° to +1000° F (-40° to +538° C)	SPDT	R1M	RKM	RKW
		DPDT	RDM	RNM	RNW
Series 9 Hermetically Sealed Snap Switch	-50° to +1000° F (-46° to +538° C)	SPDT	9AM	9KM	9KW
		DPDT	9DM	9NM	9NW

- ① Float material based on availability. Both 321SS and 347SS are stabilized austenitic stainless steels.
- ② Consult factory for TYPE 4X/7/9 cast iron housings.
- ③ Aluminum enclosure limited to +750° F (+399° C) in hazardous locations.
- ④ Process temperature based on +100° F (+38° C) ambient.
- ⑤ On steam applications, temperature down rated to +400° F (+204° C) process at +100° F (+38° C) ambient.

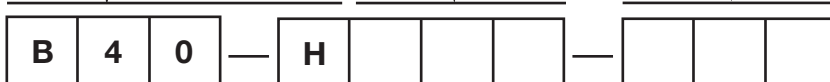

# MODEL NUMBER

## BASIC MODEL

B40-P	B40-P Liquid Level Switch for Temperatures Up To and Including +750° F (+399° F)
-------	----------------------------------------------------------------------------------

### MATERIALS OF CONSTRUCTION/PRESSURE RATING PSI (BAR)

	Chamber Material	Float Material	Tank Connection	Minimum S.G.	Temperature °F (°C)		
					100	500	750
F30	P11/F11 Chrome-Moly	321/347 SS <sup>①</sup>	1" butt-weld	0.65	1573 (108)	1573 (108)	1552 (107)
B60			1" socket weld				
C30	A105/A106 Carbon Steel		1½" socket weld		1444 (100)	1444 (100)	1251 (86)
C40	A312/A479 T316/316L SS		1½" socket weld		3700 (225)	3543 (244)	3169 (218)
C20	A105/A106 Carbon Steel		1" socket weld		1335 (92)	1335 (92)	1157 (80)

### ELECTRIC SWITCH MECHANISM AND ENCLOSURE FOR MODEL B40-PXXX ONLY

Switch Description	Process Temperature Range <sup>④</sup>	One Set Point	TYPE 4X/7/9 Aluminum Enclosure <sup>②③</sup>		
			Class I, Div. 1 Groups C & D	Class I, Div. 1 Group B	ATEX Ex II 2 G EEx d IIC T6
Series C Snap Switch	-40° to +450° F (-40° to +232° C)	SPDT	CKB	CKK	CC9
		DPDT	CNB	CNK	CF9
Series D Snap Switch for DC Current Applications	-40° to +250° F (-40° to +121° C)	SPDT	DKB	DKK	DC9
		DPDT	DNB	DNK	DF9
Series F Snap Switch Hermetically Sealed	-50° to +750° F (-46° to +399° C)	SPDT	FKB	FKK	FC9
		DPDT	FNB	FNK	FF9
Series HS 5 amp Snap Switch Hermetically Sealed w/Terminal Block <sup>⑤</sup>	-50° to +400° F (-46° to +204° C)	SPDT	HM3	HM4	HA9
		DPDT	HM7	HM8	HB9
Series HS 5 amp Snap Switch Hermetically Sealed w/Wiring Leads <sup>⑤</sup>	-50° to +400° F (-46° to +204° C)	SPDT	HMJ	HMK	—
		DPDT	HMS	HMT	—
Series R Snap Switch	-40° to +750° F (-40° to +399° C)	SPDT	RKB	RKK	RC9
		DPDT	RNB	RNK	RF9
Series S Snap Switch for AC Current Applications	-40° to +550° F (-40° to +288° C)	SPDT	SKB	SKK	SA9
		DPDT	SNB	SNK	SB9
Series S Snap Switch for DC Current Applications	-40° to +250° F (-40° to +121° C)	SPDT	SLB	SLK	SC9
		DPDT	SOB	SOK	SF9
Series 8 Hermetically Sealed Snap Switch	-50° to +750° F (-46° to +399° C)	SPDT	8KB	8KK	8C9
		DPDT	8NB	8NK	8F9
Series 9 Hermetically Sealed Snap Switch	-50° to +750° F (-46° to +399° C)	SPDT	9KB	9KK	9C9
		DPDT	9NB	9NK	9F9

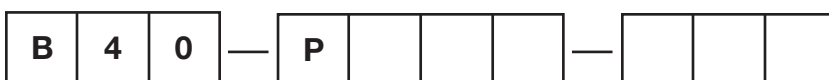

## QUALITY

---

MAGNETROL  
REGISTERED TO  
**ISO 9001**  
Your Assurance of  
Quality and Service

The quality assurance system in place at Magnetrol guarantees the highest level of quality throughout the company. Magnetrol is committed to providing full customer satisfaction both in quality products and quality service.

The Magnetrol quality assurance system is registered to ISO 9001 affirming its commitment to known international quality standards providing the strongest assurance of product/service quality available.

## WARRANTY

---



All Magnetrol mechanical level and flow controls are warranted free of defects in materials or workmanship for five full years from the date of original factory shipment. If returned within the warranty period; and, upon factory inspection of the control, the cause of the claim is determined to be covered under the warranty; then, Magnetrol will repair or replace the control at no cost

to the purchaser (or owner) other than transportation.

Magnetrol shall not be liable for misapplication, labor claims, direct or consequential damage or expense arising from the installation or use of equipment. There are no other warranties expressed or implied, except special written warranties covering some Magnetrol products.



5300 Belmont Road • Downers Grove, Illinois 60515-4499 • 630-969-4000 • Fax 630-969-9489 • [www.magnetrol.com](http://www.magnetrol.com)  
145 Jardin Drive, Units 1 & 2 • Concord, Ontario Canada L4K 1X7 • 905-738-9600 • Fax 905-738-1306  
Heikensstraat 6 • B 9240 Zele, Belgium • 052 45.11.11 • Fax 052 45.09.93  
Regent Business Ctr., Jubilee Rd. • Burgess Hill, Sussex RH15 9TL U.K. • 01444-871313 • Fax 01444-871317

Copyright © 2011 Magnetrol International, Incorporated. All rights reserved. Printed in the USA.  
Performance specifications are effective with date of issue and are subject to change without notice.  
Magnetrol & Magnetrol logotype are registered trademarks of Magnetrol International.  
CSA logotype is a registered trademark of Canadian Standards Association.

**BULLETIN: 46-128.3**  
**EFFECTIVE: May 2009**  
**SUPERCEDES: October 2007**